

# Breezy 250





# Breezy 250

Strong and durable...

Good looks...

Complete range of models  
and accessories...

Great warranty and  
after-sales service...



Breezy 250 shown with non-standard options



## Strong and durable

Its new design combined with 25mm tubing give the Breezy 250 great strength and durability. The **new tubular cross tubes** have no screws or brackets, improving the rigidity of the chair and hence aiding rolling efficiency.

## Good looks

The Breezy 250 has a new, more contemporary design with attractive coloured frame details.



Breezy 250R with 12" rear wheels, anatomical seat and backrest, headrest and elevating legrests

## Complete range of models and accessories

The Breezy 250 has a wide range of models and accessories to ensure a perfect match to the user's needs.

## Great warranty and after- sales service

- **Five year warranty on frame and cross tubes**
  - Fast and responsive after-sales service with guaranteed availability of parts
- And It's 100% made in Spain!!



# Breezy 250

## It's the details that make the difference

In creating the Breezy 250 we have used design features usually only found in high-end wheelchairs. Details like the stylish armrest panel, upholstery design and colour detailing make the Breezy 250 unique in its range.



Attractive, contemporary design with distinctive splashes of colour



Wide range of upholsteries



Footrest with accessible, ergonomic latch mechanism

## Adjustable

### Centre of Gravity Adjustment

To change the centre of gravity (i.e. adjust the distance between the front and rear wheels) the axle plate position must be changed. This allows you to create a more active or more stable wheelchair, or a smaller turning radius, depending on the depth of the chair.



Set back  
More stable

Set forward  
More active

### Three seat heights

The Breezy 250 can achieve three seat heights by combining different rear wheels and front castors.

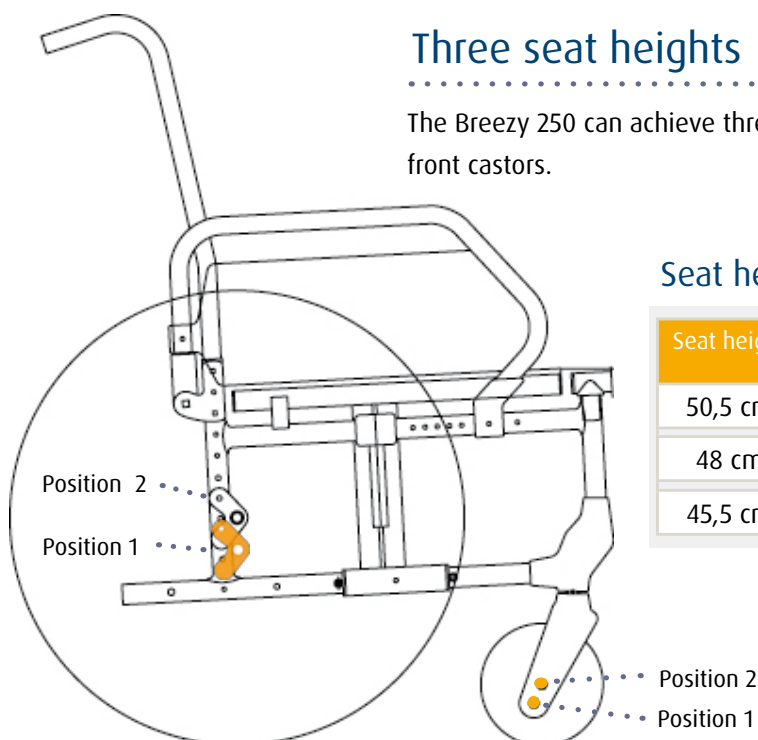

### Seat height chart

Seat height	Rear wheel	R. wheel position	Front castor	Front castor position
50,5 cm	24"	1	8"	1
48 cm	22"	1	6"	1
45,5 cm	22"	2	6"	2

Breezy 2

## Compact



### Reduced total length

The new design of the front frame and the rear wheel position give a total length of just 76.5cm without footrests. This helps the chair to gain better access to confined spaces.

## Configurable

Three backrests, four colours plus a wide range of accessories ensure the Breezy 250 can meet the user's needs perfectly.



**Breezy 250**  
Rigid backrest



**Breezy 250R**  
Reclining backrest



**Breezy 250P**  
Half-folding backrest

## Colour range

4 frame colour.



Chrome-plate



Blue



Gold



Summer red

## Wide range of options and accessories

- Height adjustable armrests
- Breathable vented upholstery
- Short legrests
- Aluminium angle adjustable footplates
- Elevating legrests
- Footboard
- Headrest
- Drum brakes
- IV pole
- Crutch holder
- Wheel lock extension
- Axle for double amputees
- Anti-tips
- Transit wheels
- Oxygen tank holder
- Tray table
- Belt
- Back pack

# Breezy 250

Rigid backrest



## Standard configuration

Standard configuration

Steel wheelchair with rigid backrest.

Nylon upholstery.

The armrests are detachable and can be folded back.

Standard footrest with 70° hanger, detachable and swing outwards and inwards.

Adjustable distance between front castor and rear wheel.

Adjustable seat height.

Colours: Chrome, Blue, Gold, and Summer red.



**Breezy 250 optional configuration**  
(12" solid rear wheel)

# Breezy 250R

Reclining backrest



Standard configuration with upholstery  
recline headrest (optional)

## Standard configuration

Steel wheelchair with reclining backrest that allows the user to be comfortably and safely reclined.

Nylon upholstery.

The armrests are detachable and can be folded back.

Standard footrest with 70° hanger, detachable and swing outwards and inwards.

Adjustable distance between front castor and rear wheel.

Adjustable seat height.

Colours: Chrome, Blue, Gold, and Summer red.





**Breezy 250R optional configuration with accessories**

12" solid rear wheel.

Anatomic seat.

Anatomic backrest.

Padded skai headrest.

Elevating legrests.

# Breezy 250P

Half-folding backrest



Standard configuration

## Standard configuration

Steel wheelchair with half-folding backrest for easier transportation and storage. The folding system is very solid and easy to use and allows a variety of backrest positions. Nylon upholstery. The armrests are detachable and can be folded back. Standard footrest with 70° hanger, detachable and swing outwards and inwards. Adjustable distance between front castor and rear wheel. Adjustable seat height. Colours: Chrome, Blue, Gold, and Summer red.



Breezy 250P, folded.



**Breezy 250P optional configuration**

12" solid rear wheel

# Options and accessories

## Legrests and footplates



Elevating legrests



Short legrests



Aluminium angle adjustable footplates



Footboard

## Upholstery

Nylon upholstery



Breathable vented upholstery



## Armrests



Long pad armrests



Height adjustable armrests

## Anatomical options and belts



Breezy 250R with reclining backrest and anatomical seat and backrest

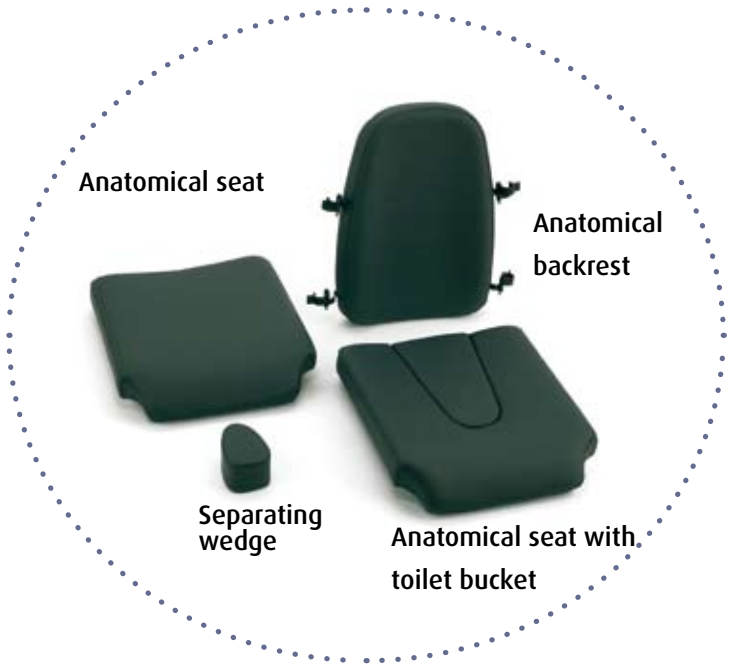

Belt

## Headrests



Anatomical headrest assembled on anatomical backrest



Std skai headrest assembled on anatomical headrest



Anatomical headrest assembled on nylon back upholstery



Std skai headrest assembled on nylon back upholstery

# Options and accessories

## Wheels



Pneumatic front castors 8"x2"



Solid front castors 8"x2"



Solid front castors 6"



Solid or Pneumatic spoke rear wheels 24" or Pneumatic spoke wheels 22"



Pneumatic mag rear wheels 24"



Solid or Pneumatic rear wheels 12"



Quick release axle on rear wheels



## Brakes



Brake extension

Drum brake wheels available with 24" and 12" rear wheels

## Accessories



Back bag



Back pack



Standard and telescopic IV pole



Crutch holder

.....



..... Oxygen bottle holder



Double amputee kit



Swing-away tray



Transit wheels



Anti-tip wheels



# Breezy 250

## Breezy 250:



37 /40 /43 /46 /49 /52 cm



42 cm

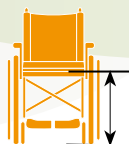

50,5 cm  
48 or 45,5 cm (con 22" y 6")

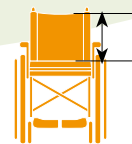

42 cm  
82 cm (Breezy 250R)

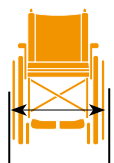

SW + 19 cm (24")  
SW + 16,5 cm (12")

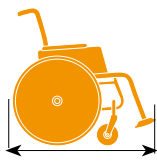

103 cm (w/ footrest)  
76,5 cm (w/o footrest)



Ruedas 12"  
95 cm (w/ footrest)  
68,5 cm (w/o footrest)

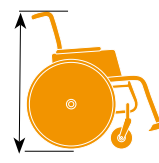

94 cm  
128 cm (Breezy 250R w/ headrest)

## Technical Specifications

Seat width:	37 /40 /43 /46/49 /52 cm	Total length reclining (Breezy 250R):	113 cm (87,5 cm w/o footrest)
Seat depth:	42 cm	Total height:	94 cm (128 cm reclining model B250R w/ headrest)
Seat height:	50,5 cm (48 ó 45,5 cm w/ 22 y 6" wheels)	Seat angle:	3°
Backrest height:	42 cm (82 cm reclining backrest Breezy 250R)	Backrest angle:	8°
Total width:	Seat width + 19 cm (24" wheels)	Frame colour:	Chrome-plated, blue, gold and summre red
	Seat width + 16,5 cm (12" wheels)	Approved user weight:	125 kg
Total length w/ 24" rear wheels:	103 cm (76,5 cm w/o footrest)	Max. weight.:	from 16.5 kg (complete)*
Total length w/ 12" rear wheels:	95 cm (68,5 cm w/o footrest)	Folded width:	31 cm

\*Measures bases on model Breezy 250, std. configuration, seat width 40 cm

Tolerance +/- 1 cm

For further information on the full specification, options and accessories, please refer to the order form.

All information is subject to change without notification. Please consult Sunrise Medical with any queries you may have.

If you are visually impaired, this document can be viewed in PDF format at [www.SunriseMedical.com](http://www.SunriseMedical.com) or alternatively is available on request in large text.



### Sunrise Medical S.L.

Polígono Bakiola, 41  
48498 Arrankudiaga  
Vizcaya, España

Tel: 902 14 24 34

Fax: 94 648 15 75

[www.SunriseMedical.es](http://www.SunriseMedical.es)