



GT / GTI

Quickie® GT & GTi

Supplier: This manual must be given to the rider of this wheelchair.

Rider: Before using this wheelchair read this entire manual and save for future reference.

Owner's Manual



SUNRISE LISTENS

Thank you for choosing a Quickie wheelchair. We want to hear your questions or comments about this manual, the safety and reliability of your chair, and the service you receive from your supplier. Please feel free to write or call us at the address and telephone number below:

SUNRISE MEDICAL

Customer Service Department
7477 East Dry Creek Parkway
Longmont, CO 80503
(303) 218-4500

Let us know your address. This will allow us to keep you up to date with information about safety, new products and options to increase your use and enjoyment of this wheelchair.

FOR ANSWERS TO YOUR QUESTIONS

Your authorized supplier knows your wheelchair best, and can answer most of your questions about chair safety, use and maintenance. For future reference, fill in the following:

Supplier: _____

Address: _____

Telephone: _____

Serial #: _____ Date/Purchased: _____

I. INTRODUCTION	2	G. Offset Seating	11
II. TABLE OF CONTENTS	3	H. Pneumatic Tires	11
III. YOUR CHAIR AND ITS PARTS	4	I. Positioning Belts	11
IV. NOTICE - READ BEFORE USE	5	J. Power Drive	11
A. Choose the Right Chair & Safety Option	5	K. Push Handles	11
B. Review this Manual Often	5	L. Quick-Release Axles	11
C. Warnings	5	M. Rear Wheels	11
V. GENERAL WARNINGS	5	N. Rear Wheel Locks	12
A. Weight Limit	5	O. Modified Seat Systems	12
B. Weight Training	5	P. Rear Suspension	12
C. Getting to Know Your Chair	5	Q. Upholstery Fabric	12
D. To Reduce The Risk of an Accident	5	R. Seat Back	12
E. Safety Checklist	5	S. Travel Wheels	12
F. Changes & Adjustments	6	IX. SET-UP AND ADJUSTMENTS	13
G. Environmental Conditions	6	A. To Mount and Remove Rear Wheels	13
H. Terrain	6	B. Rear Wheel Axle Nut Adjustment	13
I. Street Use	6	C. Padded, Swing-Away Armrests	14
J. Motor Vehicle Safety	6	D. Height Adjustable Armrests	14
K. When You Need Help	6	E. Armrest Receiver Attachment	15
VI. WARNINGS: FALLS & TIP-OVERS	7	F. Back Angle Adjustment	16
A. Center of Balance	7	G. Seat Sling Adjustment	16
B. Dressing or Changing Clothes	7	H. Adjusting Rear Seat Height	16
C. Wheelies	7	I. Cushion Installation	16
D. Obstacles	7	J. Rear Axle	17
E. Reaching or Leaning	7	K. GT w/XTR Suspension Rear Axle	18
F. Moving Backward	8	L. Rear Wheel Spacing	18
G. Ramps, Slopes & Sidehills	8	M. Casters	18
H. Transfers	8	N. Footrest Height Adjustment	19
I. Curbs & Steps	8	O. Wheel Locks	19
J. Stairs	9	P. Anti-tip Tubes	20
K. Escalators	9	Q. Anti-Tip Swing Away	20
VII. WARNINGS: FOR SAFE USE	9	R. GT w/XTR Suspension Anti-tip Tubes	21
A. Learning to do a "Wheeler"	9	S. Rear Suspension	21
B. Descending a Curb or Single Step	9	T. XTR Suspension	22
C. Climbing a Curb or Single Step	9	U. Travel Wheels	23
D. Climbing Stairs	9	V. Check-Out	23
E. Descending Stairs	9	X. TROUBLESHOOTING	24
F. Maintenance	10	XI. MAINTENANCE	25
VIII. WARNINGS: COMPONENTS & OPTIONS	10	A. Introduction	25
A. Anti-Tip Tubes	10	B. Maintenance Chart	25
B. Armrests	10	C. Maintenance Tips	25
C. Caster Pin Locks	10	D. Cleaning	25
D. Cushions & Sling Seats	10	E. Storage Tips	25
E. Fasteners	10	XII. SUNRISE LIMITED WARRANTY	26
F. Footrests	11		

III. YOUR CHAIR AND ITS PARTS

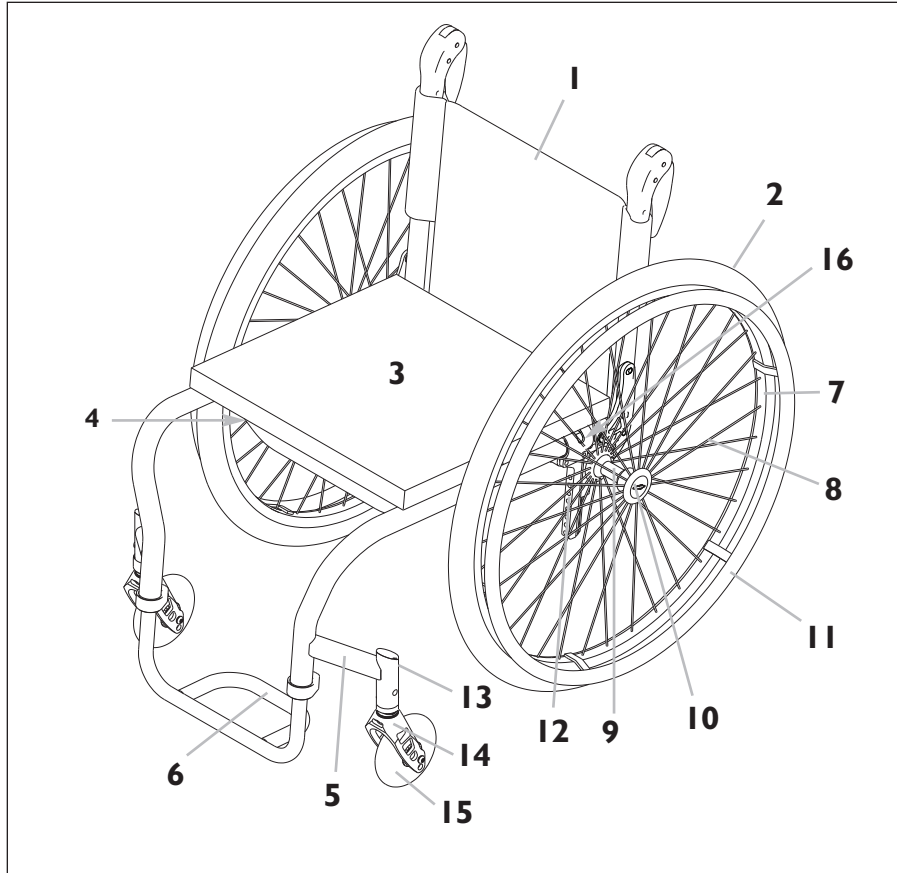

1. Backrest
2. Tire
3. Seat cushion
4. Seat sling (not shown)
5. Caster leg
6. Footrest
7. Wheel rim
8. Spokes
9. Rear wheel hub
10. Quick-release axle
11. Handrim
12. Axle plate
13. Caster housing
14. Fork
15. Caster wheel
16. Camber tube (not shown)

All features may not be available with some chair setups or in conjunction with another chair feature. Please consult your authorized supplier for more information.

QUICKIE GT / GTi

Weight

19.3 lbs. (16 x 16 w/spoke wheels)
(Chair weight will vary per component options)

Adjustments

Caster angle, CG, rear seat height, back angle, footrest length, rear wheel gap

Color

Natural Titanium Finish, Quickie colors

Frame Dimensions

Frame width: Std 12" - 20"
Seat depth: 12" - 20"
Opt- Cushion: 2"

Backrest

Non-folding
Folding Lock Down Angle Adjustable
Height-adjustable & angle: 11"-14", 12"-16", 16"-20"
Fixed Height: 10"-20"
Opt- adjustable upholstery, vented adjustable upholstery, folding push handles

Footrest

Std- Tubular
Opt- Tubular w/Cover,
Angle Adjustable Platform

Casters

Std- 5" Low-profile Polyurethane
Opt- 4" Low-profile Poly,
4" Micro Light Up
4"x1" Aluminum Poly
4"x1.5" Aluminum soft Roll
3" Micro,
3" Micro Light Up
4", 5" & 6" x 1/2" wide poly
6" Poly
Frog Legs

Armrests

Opt- Padded Swing-Away
Opt- Single-Post Height-Adjustable

Axle Bracket

Std- Fore/Aft CG Adjustable Bracket
Opt Camber- 0°, 3°, 6°, 9°

Axles

Std- stainless steel
Opt- quad-release axle nuts

Anti-tip tubes

Opt- Rear anti-tip tubes,

Standard rear wheels

Std- Spoke
Opt- Mag

Quickie Performance wheels

Opt- Heat-treated
Opt- Spinerge
Opt- Ultra lightweight
Opt- Mountain

Tire size

Std- 24"
Opt- 20", 22", 25", 26"

Tire types

Std - Pneumatic
Opt - Airless insert, Poly, Kevlar (24" only), High-pressure clinchers (24", 26" only), Mountain bike (24" only), Full Poly, Kik, Knobby V-TRAK, Schwalbe Marathon Plus, Urban Assault

Hand rims

Std- aluminum
Opt- plastic-coated
vertical/oblique projections
Natural Fit

Wheel locks

High-push, high-pull, ergo scissor
Opt- compact

Travel wheels

Opt- Rear travel wheels

IV. NOTICE— READ BEFORE USE

A. CHOOSE THE RIGHT CHAIR & SAFETY OPTIONS

Sunrise provides a choice of many wheelchair styles to meet the needs of the wheelchair rider. However, final selection of the type of wheelchair, options and adjustments rests solely with you and your health care advisor. Choosing the best chair and set-up for your safety depends on such things as:

1. Your disability, strength, balance and coordination.
2. The types of hazards you must overcome in daily use (where you live and work, and other places you are likely to use your chair).
3. The need for options for your safety and comfort (such as anti-tip tubes, positioning belts, or special seating systems).

B. REVIEW THIS MANUAL OFTEN

Before using this chair you, and each person who may assist you, should read this entire manual and make sure to follow all instructions. Review the warnings often, until they are second nature to you.

C. WARNINGS

The word “**WARNING**” refers to a hazard or unsafe practice that may cause **severe injury or death** to you or to other persons. The “Warnings” are in three main sections, as follows:

1. V — GENERAL WARNINGS

Here you will find a safety checklist and a summary of risks you need to be aware of before you ride this chair.

2. VI — WARNINGS — FALLS & TIP-OVERS

Here you will learn how to avoid a fall or tip-over while you perform daily activities in your chair.

3. VII — WARNINGS — FOR SAFE USE

Here you will learn about practices for the safe use of your chair

4. VIII — WARNINGS — COMPONENTS & OPTIONS

Here you will learn about the components of your chair and options you can select for safety. Consult your authorized supplier and your health care advisor to help you choose the best set-up and options for safe use.

NOTE— Where they apply, you will also find “Warnings” in other sections of this manual. Heed all warnings in this section. If you fail to do so a fall, tip-over or loss of control may occur and cause severe injury to the rider or others.

V. GENERAL WARNINGS

V. GENERAL WARNINGS

A. WEIGHT LIMIT

WARNING

NEVER exceed the weight limit of 265 pounds (120 kilograms), for combined weight of rider and items carried. If you do exceed the limit, damage to your chair, a fall, tip-over or loss of control may occur and cause severe injury to the rider or others.

B. WEIGHT TRAINING

WARNING

NEVER use this chair for weight training if total weight (rider plus equipment) exceeds 265 pounds. If you do exceed the limit, damage to your chair, a fall, tip-over or loss of control may occur and cause severe injury to the rider or others.

C. GETTING TO KNOW YOUR CHAIR

WARNING

Every wheelchair is different. Take the time to learn the feel of this chair before you begin riding. Start slowly, with easy, smooth strokes. If you are used to a different chair, you may use too much force and tip over. If you use too much force, damage to your chair, a fall, tip-over or loss of control may occur and cause severe injury to the rider or others.

D. TO REDUCE THE RISK OF AN ACCIDENT

WARNING

1. BEFORE riding, you should be trained in the safe use of this chair by your health care advisor.

2. Practice bending, reaching and transfers until you know the limit of your ability. Have someone help you until you know what can cause a fall or tip-over and how to avoid doing so.
3. Be aware that you must develop your own methods for safe use best suited to your level of function and ability.
4. NEVER try a new maneuver on your own until you are sure you can do it safely.
5. Get to know the areas where you plan to use your chair. Look for hazards and learn how to avoid them.
6. Use anti-tip tubes unless you are a skilled rider of this chair and are sure you are not at risk to tip over.

If you fail to heed these warnings damage to your chair, a fall, tip-over or loss of control may occur and cause severe injury to the rider or others.

E. SAFETY CHECKLIST

WARNING

Before Each Use Of Your Chair:

1. Make sure the chair rolls easily and that all parts work smoothly. Check for noise, vibration, or a change in ease of use. (They may indicate low tire pressure, loose fasteners, or damage to your chair).
2. Repair any problem. Your authorized supplier can help you find and correct the problem.
3. Check to see that both quick-release rear axles are locked. When locked, the axle button will “pop out” fully. If not locked, the wheel may come off and cause you to fall.
4. If your chair has anti-tip tubes, lock them in place.

NOTE— See “Anti-Tip Tubes” (Section VIII) for times you should not use them.

If you fail to heed these warnings damage to your chair, a fall, tip-over or loss of control may occur and cause severe injury to the rider or others.

F. CHANGES & ADJUSTMENTS

WARNING

1. If you modify or adjust this chair, it may increase the risk of a tip-over UNLESS you make other changes as well.
2. Consult your authorized supplier BEFORE you modify or adjust your chair.
3. We recommend that you use anti-tip tubes until you adapt to the change, and are sure you are not at risk to tip over.
4. Unauthorized modifications or use of parts not supplied or approved by Sunrise may change the chair structure. This will void the warranty and may cause a safety hazard.

If you fail to heed these warnings damage to your chair, a fall, tip-over or loss of control may occur and cause severe injury to the rider or others.

G. ENVIRONMENTAL CONDITIONS

WARNING

1. Use extra care if you must ride your chair on a wet or slick surface. If you are in doubt, ask for help.
2. Contact with water or excess moisture may cause your chair to rust or corrode. This could cause your chair to fail.
 - a. Do not use your chair in a shower, pool or other body of water. The chair tubing and parts are not water-tight and may rust or corrode from the inside.
 - b. Avoid excess moisture (for example, do not leave your chair in a damp bathroom while taking a shower).
 - c. Dry your chair as soon as you can if it gets wet, or if you use water to clean it.

If you fail to heed these warnings damage to your chair, a fall, tip-over or loss of control may occur and cause severe injury to the rider or others.

H. TERRAIN

WARNING

1. Your chair is designed for use on firm, even surfaces such as concrete, asphalt and indoor floors and carpeting.
2. Do not operate your chair in sand, loose soil or over rough terrain. This may damage wheels or axles, or loosen fasteners of your chair.

If you fail to heed these warnings damage to your chair, a fall, tip-over or loss of control may occur and cause severe injury to the rider or others.

I. STREET USE

WARNING

In most states, wheelchairs are not legal for use on public roads. Be alert to the danger of motor vehicles on roads or in parking lots.

1. At night, or when lighting is poor, use reflective tape on your chair and clothing.
2. Due to your low position, it may be hard for drivers to see you. Make eye contact with drivers before you go forward. When in doubt, yield until you are sure it is safe.

If you fail to heed these warnings damage to your chair, a fall, tip-over or loss of control may occur and cause severe injury to the rider or others.

J. MOTOR VEHICLE SAFETY

WARNING

Quickie wheelchairs do not meet federal standards for motor vehicle seating.

1. NEVER let anyone sit in this chair while in a moving vehicle.
 - a. ALWAYS move the rider to an approved vehicle seat.
 - b. ALWAYS secure the rider with proper motor vehicle restraints.
2. In an accident or sudden stop the rider may be thrown from the chair. Wheelchair seat belts will not prevent this, and further injury may result from the belts or straps.
3. NEVER transport this chair in the front seat of a vehicle. It may shift and interfere with the driver.
4. ALWAYS secure this chair so that it cannot roll or shift.
5. Do not use any chair that has been involved in a motor vehicle accident.

If you fail to heed these warnings damage to your chair, a fall, tip-over or loss of control may occur and cause severe injury to the rider or others.

K. WHEN YOU NEED HELP

WARNING

For The Rider:

Make sure that each person who helps you reads and follows all warnings and instructions that apply.

For Attendants:

1. Work with the rider's doctor, nurse or therapist to learn safe methods best suited to your abilities and those of the rider.
2. Tell the rider what you plan to do, and explain what you expect the rider to do. This will put the rider at ease and reduce the risk of an accident.
3. Make sure the chair has push handles. They provide secure points for you to hold the rear of the chair to prevent a fall or tip-over. Check to make sure push handle grips will not rotate or slip off.
4. To prevent injury to your back, use good posture and proper body mechanics. When you lift or support the rider or tilt the chair, bend your knees slightly and keep your back as upright and straight as you can.
5. Remind the rider to lean back when you tilt the chair backward.
6. When you descend a curb or single step, slowly lower the chair in one easy movement. Do not let the chair drop the last few inches to the ground. This may damage the chair or injure the rider.
7. To avoid tripping, unlock and rotate anti-tip tubes up, out of the way. ALWAYS lock the rear wheels and lock anti-tip tubes in place if you must leave the rider alone, even for a moment. This will reduce the risk of a tip over or loss of control of the chair.

If you fail to heed these warnings damage to your chair, a fall, tip-over or loss of control may occur and cause severe injury to the rider or others.

VI. WARNINGS: FALLS & TIP-OVERS

A. CENTER OF BALANCE

WARNING

The point where this chair will tip forward, back, or to the side depends on its center of balance and stability. How your chair is set up, the options you select and the changes you make may affect the risk of a fall or tip-over.

1. The most important adjustment is the position of the rear wheels. The more you move the rear wheels forward, the more likely your chair will tip over backward.
2. The center of balance is also affected by:
 - a. A change in the set-up of your chair, including:
 - The distance between the rear wheels.
 - The amount of rear wheel camber.
 - The seat height and seat angle.
 - Backrest angle.
 - b. A change in your body position, posture or weight distribution.
 - c. Riding your chair on a ramp or slope.
 - d. The use of a back pack or other options, and the amount of added weight.
3. To reduce the risk of an accident:
 - a. Consult your doctor, nurse or therapist to find out what axle and caster position is best for you.
 - b. Consult your authorized supplier BEFORE you modify or adjust this chair. Be aware that you may need to make other changes to correct the center of balance.
 - c. Have someone help you until you know the balance points of your chair and how to avoid a tip-over.
 - d. Use anti-tip tubes.

If you fail to heed these warnings damage to your chair, a fall, tip-over or loss of control may occur and cause severe injury to the rider or others.

B. DRESSING OR CHANGING CLOTHES

WARNING

Your weight may shift if you dress or change clothes while seated in this chair. To reduce the risk of a fall or tip-over:

1. Rotate the front casters until they are as far forward as possible. This makes the chair more stable.
2. Lock anti-tip tubes in place. (If your chair does not have anti-tip tubes, back it up against a wall and lock both rear wheels).

If you fail to heed these warnings damage to your chair, a fall, tip-over or loss of control may occur and cause severe injury to the rider or others.

C. WHEELIES

WARNING

Doing a “wheelie” means: balancing on the rear wheels of your chair, while the front casters are in the air. It is dangerous to do a “wheelie” as a fall or tip-over may occur. However, if you do it safely, a “wheelie” can help you overcome curbs and obstacles.

1. Consult your doctor, nurse or therapist to find out if you are a good candidate to learn to do a “wheelie.”
2. Do not attempt a “wheelie” UNLESS you are a skilled rider of this chair, or you have help.

NOTE– See Section VII-A for steps to learn to do a “wheelie.”

If you fail to heed these warnings damage to your chair, a fall, tip-over or loss of control may occur and cause severe injury to the rider or others.

D. OBSTACLES

WARNING

Obstacles and road hazards (such as potholes and broken pavement) can damage your chair and may cause a fall, tip-over or loss of control.

To avoid these risks:

1. Keep a lookout for danger – scan the area well ahead of your chair as you ride.
2. Make sure the floor areas where you live and work are level and free of obstacles.
3. Remove or cover threshold strips between rooms.
4. Install a ramp at entry or exit doors. Make sure there is not a drop off at the bottom of the ramp.
5. To Help Correct Your Center Of Balance:
 - a. Lean your upper body FORWARD slightly as you go UP over an obstacle.
 - b. Press your upper body BACKWARD as you go DOWN from a higher to a lower level.
6. If your chair has anti-tip tubes, lock them in place before you go UP over an obstacle.
7. Keep both of your hands on the handrims as you go over an obstacle.
8. Never push or pull on an object (such as furniture or a door-jamb) to propel your chair.

If you fail to heed these warnings damage to your chair, a fall, tip-over or loss of control may occur and cause severe injury to the rider or others.

E. REACHING OR LEANING

WARNING

If you reach or lean it will affect the center of balance of your chair. This may cause you to fall or tip over. When in doubt, ask for help or use a device to extend your reach.

1. NEVER reach or lean if you must shift your weight sideways or rise up off the seat.
2. NEVER reach or lean if you must move forward in your seat to do so. Always keep your buttocks in contact with the backrest.
3. NEVER reach with both hands (you may not be able to catch yourself to prevent a fall if the chair tips).
4. NEVER reach or lean to the rear unless your chair has anti-tip tubes locked in place.
5. DO NOT reach or lean over the top of the seat back. This may damage one or both backrest tubes and cause you to fall.
6. If You Must Reach Or Lean:
 - a. Do not lock the rear wheels. This creates a tip point and makes a fall or tip-over more likely.
 - b. Do not put pressure on the footrests.

NOTE– Leaning forward puts pressure on the footrests and may cause the chair to tip if you lean too far.
 - c. Move your chair as close as you can to the object you wish to reach.
 - d. Do not try to pick up an object from the floor by reaching down between your knees. You are less likely to tip if you reach to the side of your chair.
 - e. Rotate the front casters until they are as far forward as possible. This makes the chair more stable.

NOTE– To do this: Move your chair past the object you want to reach, then back up alongside it. Backing up will rotate the casters forward.
 - f. Firmly grasp a rear wheel or an armrest with one hand. This will help to prevent a fall if the chair tips.

If you fail to heed these warnings damage to your chair, a fall, tip-over or loss of control may occur and cause severe injury to the rider or others.

F. MOVING BACKWARD

⚠ WARNING

Use extra care when you move your chair backward. Your chair is most stable when you propel yourself forward. You may lose control or tip over if one of the rear wheels hits an object and stops rolling.

1. Propel your chair slowly and smoothly.
2. If your chair has anti-tip tubes, make sure to lock them in place.
3. Stop often and check to be sure your path is clear.

If you fail to heed these warnings damage to your chair, a fall, tip-over or loss of control may occur and cause severe injury to the rider or others.

G. RAMPS, SLOPES & SIDEHILLS

⚠ WARNING

Riding on a slope, which includes a ramp or side hill, will change the center of balance of your chair. Your chair is less stable when it is at an angle. Anti-tip tubes may not prevent a fall or tip-over.

1. Do not use your chair on a slope steeper than 10%. (A 10% slope means: one foot in elevation for every ten feet of slope length.)
2. Always go as straight up and as straight down as you can. (Do not “cut the corner” on a slope or ramp.)
3. Do not turn or change direction on a slope.
4. Always stay in the CENTER of the ramp. Make sure ramp is wide enough that you are not at risk that a wheel may fall over the edge.
5. Do not stop on a steep slope. If you stop, you may lose control of your chair.
6. NEVER use rear wheel locks to try to slow or stop your chair. This is likely to cause your chair to veer out of control.
7. Beware Of:
 - a. Wet or slippery surfaces.
 - b. A change in grade on a slope (or a lip, bump or depression). These may cause a fall or tip-over.
 - c. A drop-off at the bottom of a slope. A drop-off of as small as 3/4 inch can stop a front caster and cause the chair to tip forward.
8. To Reduce The Risk Of A Fall Or Tip-Over:
 - a. Lean or press your body UPHILL. This will help adjust for the change in the center of balance caused by the slope or side hill.
 - b. Keep pressure on the handrims to control your speed on a down slope. If you go too fast you may lose control.
 - c. Ask for help any time you are in doubt.
9. Ramps At Home & Work - For your safety, ramps at home and work must meet all legal requirements for your area. We recommend:
 - a. Width. At least four feet wide.
 - b. Guardrails. To reduce the risk of a fall, sides of ramp must have guardrails (or raised borders at least three inches high).
 - c. Slope. Not more than a 10% grade.
 - d. Surface. Flat and even, with a thin carpet or other non-skid material. (Make sure there is no lip, bump or depression.)
 - e. Bracing. Ramp must be STURDY. You may need bracing so ramp does not “bow” when you ride on it.
 - f. Avoid A Drop Off. You may need a section at the top or bottom to smooth out the transition.

If you fail to heed these warnings damage to your chair, a fall, tip-over or loss of control may occur and cause severe injury to the rider or others.

H. TRANSFER

⚠ WARNING

It is dangerous to transfer on your own. It requires good balance and agility. Be aware that there is a point during every transfer when the wheelchair seat is not below you.

To Avoid A Fall:

1. Work with your health care advisor to learn safe methods.
 - a. Learn how to position your body and how to support yourself during a transfer.
 - b. Have someone help you until you know how to do a safe transfer on your own.
 2. Lock the rear wheels before you transfer. This keeps the rear wheels from rolling.
- NOTE**– This will NOT keep your chair from sliding away from you or tipping.
3. Make sure to keep pneumatic tires properly inflated. Low tire pressure may allow the rear wheel locks to slip.
 4. Move your chair as close as you can to the seat you are transferring to. If possible, use a transfer board.
 5. Rotate the front casters until they are as far forward as possible.
 6. If you can, remove or swing footrests out of the way.
 - a. Make sure your feet do not catch in the space between the footrests.
 - b. Avoid putting weight on the footrests as this may cause the chair to tip.
 7. Make sure armrests are out of the way and do not interfere.
 8. Transfer as far back onto the seat surface as you can. This will reduce the risk that the chair will tip or move away from you.

If you fail to heed these warnings damage to your chair, a fall, tip-over or loss of control may occur and cause severe injury to the rider or others.

I. CURBS & STEPS

⚠ WARNING

1. Each person who helps you should read and follow the warnings “For Safe Use” (Section VII).
2. Do not try to climb or descend a curb or step alone UNLESS you are a skilled rider of this chair and:
 - a. You can safely do a “wheelie”; and
 - b. You are sure you have the strength and balance to do so.
3. Unlock and rotate anti-tip tubes up, out of the way, so they do not interfere.
4. Do not try to climb a high curb or step (more than 4 inches high) UNLESS you have help. Doing so may cause your chair to exceed its balance point and tip over.
5. Go straight up and straight down a curb or step. If you climb or descend at an angle, a fall or tip-over is likely.
6. Be aware that the impact of dropping down from a curb or step can damage your chair or loosen fasteners.

If you fail to heed these warnings damage to your chair, a fall, tip-over or loss of control may occur and cause severe injury to the rider or others.

J. STAIRS

WARNING

1. NEVER use this chair on stairs UNLESS you have someone to help you. Doing so is likely to cause a fall or tip-over.
2. Persons who help you should read and follow the warnings “For Attendants” (Section V-K), and the “For Safe Use” (Section VII).

If you fail to heed these warnings damage to your chair, a fall, tip-over or loss of control may occur and cause severe injury to the rider or others.

K. ESCALATORS

WARNING

NEVER use this chair on an escalator, even with an attendant. If you do, a fall or tip-over is likely.

If you fail to heed these warnings damage to your chair, a fall, tip-over or loss of control may occur and cause severe injury to the rider or others.

VII. WARNINGS: FOR SAFE USE

VII. WARNINGS: FOR SAFE USE

WARNING

Before you assist a rider, be sure to read the warnings “For Attendants” (Section V-K) and follow all instructions that apply. Be aware that you will need to learn safe methods best suited to your abilities.

A. LEARNING TO DO A “WHEELIE”

WARNING

Follow these steps to help the rider learn to do a “wheelie”:

1. Read and follow the warnings for “WHEELIES.” (Section VI-C)
2. Stand at the rear of the chair. You must be able to move with the chair to prevent a tip-over.
3. Keep your hands BENEATH the push handles, ready to catch the rider if the chair tips back.
4. When you are ready, have the rider place his or her hands on the forward part of the handrims.
5. Have the rider make a quick BACKWARD movement of the rear wheels, quickly followed by a hard FORWARD thrust. (This will tilt the chair up on the balance point of the rear wheels.)
6. Have the rider make small movements of the handrims to stay in balance.

If you fail to heed these warnings damage to your chair, a fall, tip-over or loss of control may occur and cause severe injury to the rider or others.

B. DESCENDING A CURB OR SINGLE STEP

WARNING

Follow these steps to help a rider descend a curb or single step going BACKWARD:

1. Stay at the rear of the chair.
2. Several feet before you reach the edge of the curb or step, turn the chair around and pull it backward.
3. While looking over your shoulder, carefully step back until you are off the curb or stair and standing on the lower level.
4. Pull the chair toward you until the rear wheels reach the edge of the curb or step. Then allow the rear wheels to slowly roll down onto the lower level.

5. When the rear wheels are safely on the lower level, tilt the chair back to its balance point. This will lift the front casters off the curb or step.
6. Keep the chair in balance and take small steps backward. Turn the chair around and gently lower front casters to the ground.

If you fail to heed these warnings damage to your chair, a fall, tip-over or loss of control may occur and cause severe injury to the rider or others.

C. CLIMBING A CURB OR SINGLE STEP

WARNING

Follow these steps to help the rider climb a curb or single step going FORWARD:

1. Stay behind the chair.
2. Face the curb and tilt the chair up on the rear wheels so that the front casters clear the curb or step.
3. Move forward, placing the front casters on the upper level as soon as you are sure they are past the edge.
4. Continue forward until the rear wheels contact the face of the curb or step. Lift and roll the rear wheels to the upper level.

If you fail to heed these warnings damage to your chair, a fall, tip-over or loss of control may occur and cause severe injury to the rider or others.

D. CLIMBING STAIRS

WARNING

1. Use at least two attendants to move a chair and rider up stairs.
2. Move the chair and rider BACKWARD up the stairs.
3. The person at the rear is in control. He or she tilts the chair back to its balance point.
4. A second attendant at the front firmly grasps a non-detachable part of the front frame and lifts the chair up and over one stair at a time.
5. The attendants move to the next stair up. Repeat for each stair, until you reach the landing.

If you fail to heed these warnings damage to your chair, a fall, tip-over or loss of control may occur and cause severe injury to the rider or others.

E. DESCENDING STAIRS

WARNING

1. Use at least two attendants to move a chair and rider down stairs.

2. Move the chair and rider FORWARD down the stairs.
3. The person at the rear is in control. He or she tilts the chair to the balance point of the rear wheels and rolls it to the edge of the top step.
4. A second attendant stands on the third step from the top and grasps the chair frame. He or she lowers the chair one step at a time by letting the rear wheels roll over the stair edge.
5. The attendants move to the next stair down. Repeat for each stair, until you reach the landing.

If you fail to heed these warnings damage to your chair, a fall, tip-over or loss of control may occur and cause severe injury to the rider or others.

F. MAINTENANCE

WARNING

1. Inspect and maintain this chair strictly per the maintenance chart located in the maintenance section of this manual.
2. If you detect a problem, make sure to service or repair the chair before use.
3. At least once a year, have a complete inspection, safety check and service of your chair made by an authorized supplier.

If you fail to heed these warnings damage to your chair, a fall, tip-over or loss of control may occur and cause severe injury to the rider or others.

For additional maintenance information see Section XI: Maintenance.

VIII. WARNINGS: COMPONENTS & OPTIONS

A. ANTI-TIP TUBES (OPTIONAL)

WARNING

Anti-tip tubes can help keep your chair from tipping over backward in most normal conditions.

1. Sunrise Recommends Use Of Anti-Tip Tubes:
 - a. UNLESS you are a skilled rider of this chair and are sure you are not at risk to tip over.
 - b. Each time you modify or adjust your chair. The change may make it easier to tip backward. Use anti-tip tubes until you adapt to the change, and are sure you are not at risk to tip over.
2. When locked in place (in the “down” position) anti-tip tubes should be BETWEEN 1 1/2 to 2 inches off the ground.
 - a. If set too HIGH, they may not prevent a tip-over.
 - b. If set too LOW, they may “hang up” on obstacles you can expect in normal use. If this occurs, you may fall or your chair may tip over.
3. Keep Anti-Tip Tubes Locked In Place UNLESS:
 - a. You have an attendant; or
 - b. You have to climb or descend a curb, or overcome an obstacle, and can safely do so without them. At these times, make sure anti-tip tubes are up, out of the way.

If you fail to heed these warnings damage to your chair, a fall, tip-over or loss of control may occur and cause severe injury to the rider or others.

B. ARMRESTS

WARNING

Armrests detach and will not bear the weight of this chair.

1. NEVER lift this chair by its armrests. They may come loose or break.
2. Lift this chair only by non-detachable parts of the main frame.

If you fail to heed these warnings damage to your chair, a fall, tip-over or loss of control may occur and cause severe injury to the rider or others.

VIII. WARNINGS: COMPONENTS & OPTIONS

C. CASTER PIN-LOCKS

WARNING

Always use both pin locks when transferring in and out of the chair.

Caster pin locks only keep the front caster wheels from changing direction, they do not lock-out the front wheels from rotation. To prevent the wheelchair from rolling, you must engage the rear wheel locks.

If you propel your wheelchair with the caster pin locks engaged, the chair will be prevented from turning.

If you fail to heed these warnings damage to your chair, a fall, tip-over or loss of control may occur and cause severe injury to the rider or others.

D. CUSHIONS & SLING SEATS

WARNING

1. Quickie sling seats and standard foam cushions are not designed for the relief of pressure.
2. If you suffer from pressure sores, or if you are at risk that they will occur, you may need a special seat system or a device to control your posture. Consult your doctor, nurse or therapist to find out if you need such a device for your well-being.

If you fail to heed these warnings damage to your chair, a fall, tip-over or loss of control may occur and cause severe injury to the rider or others.

E. FASTENERS

WARNING

Many of the screws, bolts and nuts on this chair are special high-strength fasteners. Use of improper fasteners may cause your chair to fail.

1. ONLY use fasteners provided by an authorized supplier (or ones of the same type and strength, as indicated by the markings on the heads).
2. Over- or under-tightened fasteners may fail or cause damage to chair parts.
3. If bolts or screws become loose, tighten them as soon as you can. If you fail to heed these warnings damage to your chair, a fall, tip-over or loss of control may occur and cause severe injury to the rider or others.

If you fail to heed these warnings damage to your chair, a fall, tip-over or loss of control may occur and cause severe injury to the rider or others.

F. FOOTRESTS

WARNING

1. At the lowest point, footrests should be AT LEAST 2" off the ground. If set too LOW, they may "hang up" on obstacles you can expect to find in normal use. This may cause the chair to stop suddenly and tip forward.
2. To Avoid A Trip Or Fall When You Transfer:
 - a. Make sure your feet do not "hang up" or get caught in the space between the footrests.
 - b. Avoid putting weight on the footrests, as the chair may tip forward.
3. NEVER lift this chair by the footrests. Footrests detach and will not bear the weight of this chair. Lift this chair only by non-detachable parts of the main frame.

If you fail to heed these warnings damage to your chair, a fall, tip-over or loss of control may occur and cause severe injury to the rider or others.

G. OFFSET SEATING (OPTIONAL)

WARNING

1. A fore/aft change in the backrest position will affect the center of balance of your chair.
2. Only use this option when installing a forward offset mounted seating solution, not using the standard back sling.
3. Each time you adjust or modify the backrest plane location, the change may make it easier to tip backwards. Use anti-tips until you adapt to the change, and are sure you are not at risk to tip over.

If you fail to heed these warnings damage to your chair, a fall, tip-over or loss of control may occur and cause severe injury to the rider or others.

H. PNEUMATIC TIRES

WARNING

Proper inflation extends the life of your tires and makes your chair easier to use.

1. Do not use this chair if any of the tires is under- or over-inflated. Check weekly for proper inflation level, as listed on the tire sidewall.
2. Low pressure in a rear tire may cause the wheel lock on that side to slip and allow the wheel to turn when you do not expect it.
3. Low pressure in any of the tires may cause the chair to veer to one side and result in a loss of control.
4. Over-inflated tires may burst.

If you fail to heed these warnings damage to your chair, a fall, tip-over or loss of control may occur and cause severe injury to the rider or others.

I. POSITIONING BELTS (OPTIONAL)

WARNING

Use positioning belts ONLY to help support the rider's posture. Improper use of these belts may cause severe injury to or death of the rider.

1. Make sure the rider does not slide down in the wheelchair seat. If this occurs, the rider may suffer chest compression or suffocate due to pressure from the belts.
2. The belts must be snug, but must not be so tight that they interfere with breathing. You should be able to slide your open hand, flat, between the belt and the rider.

3. A pelvic wedge or a similar device can help keep the rider from sliding down in the seat. Consult with the rider's doctor, nurse or therapist to find out if the rider needs such a device.
4. Use positioning belts only with a rider who can cooperate. Make sure the rider can easily remove the belts in an emergency.
5. NEVER Use Positioning Belts:
 - a. As a patient restraint. A restraint requires a doctor's order.
 - b. On a rider who is comatose or agitated.
 - c. As a motor vehicle restraint. In an accident or sudden stop the rider may be thrown from the chair. Wheelchair seat belts will not prevent this, and further injury may result from the belts or straps.

If you fail to heed these warnings damage to your chair, a fall, tip-over or loss of control may occur and cause severe injury to the rider or others.

J. POWER DRIVE (OPTIONAL)

WARNING

Do not install a non Quickie-approved power drive on any Quickie wheelchair. If you do:

1. It will affect the center of balance of your chair and may cause a fall or tip-over.
2. It will alter the frame and void the warranty.

If you fail to heed these warnings damage to your chair, a fall, tip-over or loss of control may occur and cause severe injury to the rider or others.

K. PUSH HANDLES (OPTIONAL)

WARNING

When you have an attendant, make sure that this chair has push handles.

1. Push handles provide secure points for an attendant to hold the rear of this chair, to prevent a fall or tip-over. Make sure to use push handles when you have an attendant.
2. Check to make sure push handle grips will not rotate or slip off.

If you fail to heed these warnings damage to your chair, a fall, tip-over or loss of control may occur and cause severe injury to the rider or others.

L. QUICK-RELEASE AXLES

WARNING

1. Do not use this chair UNLESS you are sure that both quick-release rear axles are locked. An unlocked axle may come off during use and cause a fall.
2. An axle is not locked until the quick-release button pops out fully. An unlocked axle may come off during use, resulting in a fall, tip-over or loss of control and cause severe injury to the rider or others.

If you fail to heed these warnings damage to your chair, a fall, tip-over or loss of control may occur and cause severe injury to the rider or others.

M. REAR WHEELS

WARNING

A change in set-up of the rear wheels will affect the center of balance of your chair.

1. The farther you move the rear axles FORWARD, the more likely it is that your chair will tip over backward.
2. Consult your doctor, nurse or therapist to find the best rear axle set-up for your chair. Do not change the set-up UNLESS you are sure you are not at risk to tip over.

3. Adjust the rear wheel locks after you make any change to the rear axles.
 - a. If you fail to do so, the locks may not work.
 - b. Make sure lock arms embed in tires at least 1/8 inch when locked.

If you fail to heed these warnings damage to your chair, a fall, tip-over or loss of control may occur and cause severe injury to the rider or others.

N. REAR WHEEL LOCKS (OPTIONAL)

WARNING

Rear wheel locks are NOT designed to slow or stop a moving wheelchair. Use them only to keep the rear wheels from rolling when your chair is at a complete stop.

1. NEVER use rear wheel locks to try to slow or stop your chair when it is moving. Doing so may cause you to veer out of control.
2. To keep the rear wheels from rolling, always set both rear wheel locks when you transfer to or from your chair.
3. Low pressure in a rear tire may cause the wheel lock on that side to slip and may allow the wheel to turn when you do not expect it.
4. Make sure lock arms embed in tires at least 1/8 inch when locked. If you fail to do so, the locks may not work.

If you fail to heed these warnings damage to your chair, a fall, tip-over or loss of control may occur and cause severe injury to the rider or others.

O. MODIFIED SEAT SYSTEMS

WARNING

Use of a seat system not approved by Sunrise may alter the center of balance of this chair. This may cause the chair to tip over.

Do not change the seat system of your chair UNLESS you consult your authorized supplier first.

If you fail to heed these warnings damage to your chair, a fall, tip-over or loss of control may occur and cause severe injury to the rider or others.

P. REAR SUSPENSION (OPTIONAL)

WARNING

When replacing the suspension bushings, always use genuine Quickie parts. Use of non-Quickie replacement parts voids the warranty and could cause structural failure.

If you fail to heed these warnings damage to your chair, a fall, tip-over or loss of control may occur and cause severe injury to the rider or others.

Q. UPHOLSTERY FABRIC

WARNING

1. Replace worn or torn fabric of seat and seat back as soon as you can. If you fail to do so, the seat may fail.
2. Sling fabric will weaken with age and use. Look for fraying or thin spots, or stretching of fabrics at rivet holes.
3. "Dropping down" into your chair will weaken fabric and result in the need to inspect and replace the seat more often.
4. Be aware that laundering or excess moisture will reduce flame retardation of the fabric.

If you fail to heed these warnings damage to your chair, a fall, tip-over or loss of control may occur and cause severe injury to the rider or others.

R. SEAT BACK

WARNING

Adjusting the seat back depth could cause the strut tube to be located in a position where it could contact the user and cause skin breakdown or other serious injuries.

If you fail to heed these warnings damage to your chair, a fall, tip-over or loss of control may occur and cause severe injury to the rider or others.

S. TRAVEL WHEELS

WARNING

- Do not exceed 265 lb total weight.
- Intermittent use only.
- May decrease rearward stability.

IX. SET-UP & ADJUSTMENT

NOTE ON TORQUE SETTINGS— A torque setting is the optimum tightening which should be made on a particular fastener. It is important to use proper torque settings where specified.

A. TO MOUNT & REMOVE REAR WHEELS 1 2

⚠ WARNING

Do not use this chair **UNLESS** you are sure both quick-release axles are locked. An unlocked axle may come off during use and cause a fall.

NOTE— Setting the wheelchair on a flat surface, such as a workbench or table, helps make these procedures easier.

1. To Install Wheel

- Depress quick-release button (A) fully.
- Insert axle (B) through hub of rear wheel.
- Keep button (A) depressed as you slide axle (B) into camber plug (C).
- Release button to lock axle in camber plug. Adjust axle if it does not lock. See Section B.
- Repeat steps on other side.

2. To Remove Wheel

- Depress quick-release button (A) fully.
- Remove wheel by sliding axle (B) completely out of camber plug (C).
- Repeat steps on other side.

NOTE— The axle is not locked until the quick-release button pops out fully (A). Check that the axle is locked by pulling on the wheel in the direction of the axle.

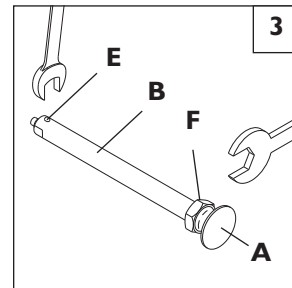
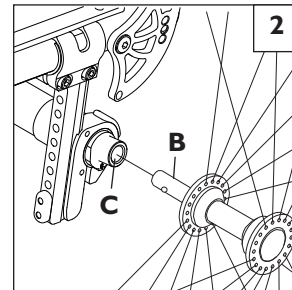
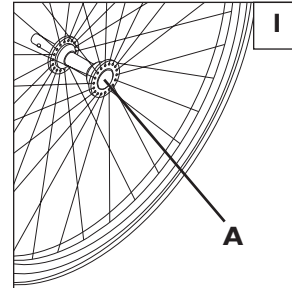

B. REAR WHEEL AXLE NUT ADJUSTMENT 3 4

The rear wheel axle (B) attaches the rear wheel (D) to the camber plug (C). When the detent balls (E) engage into the camber plug the rear wheel effectively becomes locked onto the chair. Pushing the quick-release button (A) disengages the detent balls and allows removal of the axle and wheel assembly.

To adjust the axle you will need a 3/4" wrench to turn the adjustment nut (F). You will also need a 1/2" wrench to securely hold the ball detent end of the axle to prevent it from turning.

If the wheel and axle will not lock into the camber plug then the axle requires adjustment. Turn the nut counter-clockwise approximately 1/4 revolution and try to lock the axle into the camber plug. If it doesn't lock, continue making small nut adjustments until it securely locks.

If the wheel is locked on the chair but there is excessive wheel play (the wheel hub can be pushed back and forth on the axle) then adjust the nut clockwise until there is no perceptible gap between the wheel and camber tube and the axle is securely locked onto the chair.

CAUTION— Quick-release button (A) must be flush with the edge of the wheel hub for detent balls (E) to be engaged.

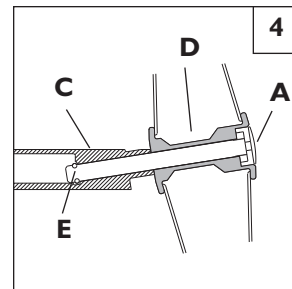

C. PADDED SWING-AWAY ARMRESTS (Optional) 5 6

Swing-away armrests can be detached or can swing away to allow lateral transfers. They are height adjustable (2") by moving bolts (A) up or down in predrilled holes on armrest bracket.

Swing-away, removable armrests are installed by sliding armrest into receiver (B) on back frame.

Swing-away, angle adjustable 6

To change the angle, remove bolts (C), reposition to needed angle. Reinsert bolt and tighten.

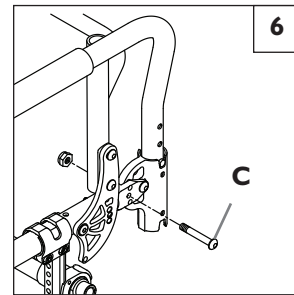
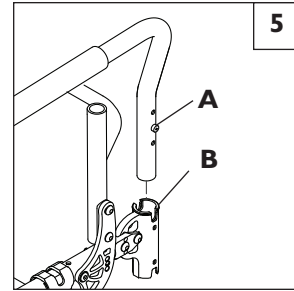
**D. HEIGHT-ADJUSTABLE ARMRESTS** (Optional) 7 7a**1. Installation**

- a. Slide the outer armpost into the receiver mounted to the wheelchair frame.
- b. The armrest will automatically lock into place.

2. Height Adjustment

- a. Rotate height release lever (2) to second stop.
- b. Slide armrest pad up or down to desired height.
- c. Return lever to locked position against armpost.
- d. Push arm pad (4) until upper armpost locks firmly into place.

3. Removing Armrest

- a. Rotate height release lever (2) to first stop and remove the armrest.

4. Replacing Armrest

- a. Slide armrest back into receiver.
- b. Return release lever (2) to locked position against armpost.

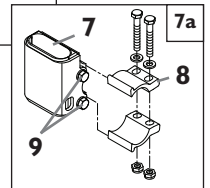
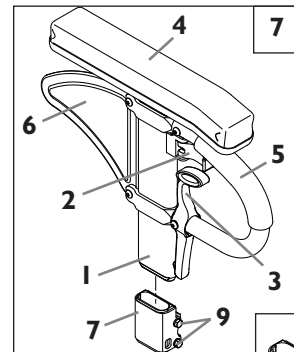

1. Outer armpost
2. Height Release Lever
3. Release lever
4. Armrest pad
5. Transfer bar
6. Side panel
7. Receiver
8. Clamp
9. Receiver adjustment hardware

E. ARMREST RECEIVER ATTACHMENT

Mounting 8 9 10

1. Place the two clamp receivers (A) over the top portion of the rear side frame tube. 8
Align with the single post height-adjustable armrest.
2. Pinch both clamp receivers together at the armrest receiver side and insert into the armrest receiver (B) 9.
3. Once inserted, pinch both clamp receivers together on the far side of the armrest receiver. 10
4. Hold both clamp receivers against the top portion of the rear side frame tube and fasten 10.

Adjustment 11 12

1. To adjust the fit of the Single Post Armrest in the receiver, loosen the 4 hex bolts (A) by using a 7/16" wrench 11.
2. With the armrest assembly in the receiver (C), press firmly on the outside of the receiver (B). 12
3. Maintain pressure on the receiver and re-tighten two of the hex bolts.
4. Remove the armrest assembly and re-tighten the remaining two hex bolts.
5. The armrest will fit firmly in the receiver and lessen any noise that may result from vibration.

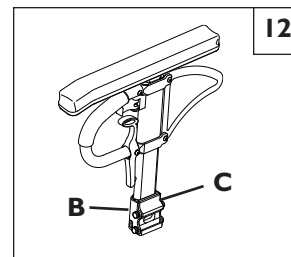
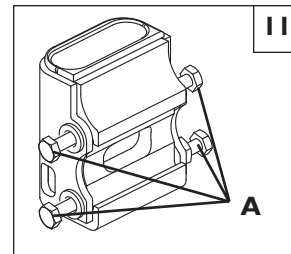
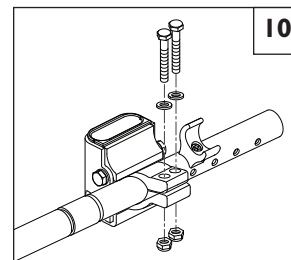
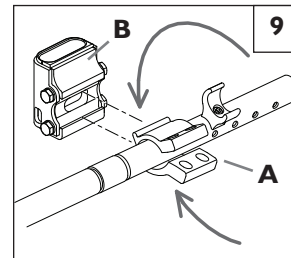
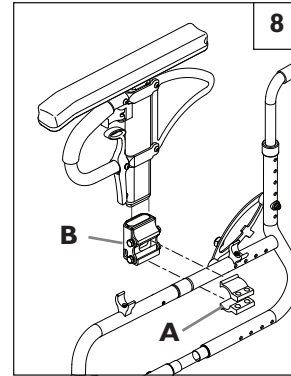

F. BACK ANGLE ADJUSTMENT 13 14

Adjusting the Back Angle 13

1. Release the backrest by pulling the release cord (A) with a simple, short force.
2. While maintaining tension on the release cord, rotate the backrest to the desired angle or to the folded down position.
3. Lock the backrest in place by releasing the cord and allowing the pins (B) to engage in the nearest hole (C) of the backrest bracket (D).

CAUTION– Be sure the pins (B) are fully engaged through the backrest bracket (D) on both sides of the chair. Test the backrest to be sure it is locked before use.

CAUTION – When changing the back angle of the wheelchair both the left and right angle adjustable back bracket must be in the same hole position before the wheelchair is to be used.

Non-folding back instructions 14

1. Remove backrest bracket bolt (E).
2. Rotate the backrest to the desired angle.
3. Align desired backrest bracket hole with seat frame opening.
4. Reinsert bolt and tighten.

CAUTION – When changing the back angle of the wheelchair both the left and right angle adjustable back bracket must be in the same hole position before the wheelchair is to be used.

Backrest Angle Preset Plugs 15

The preset plugs allow you to unemploy the backrest bracket holes you do not wish to use. This allows the backrest to automatically lock into your desired angle position after unfolding.

1. Determine which backrest bracket holes you do not want to use.
2. Insert plugs (F) into the predetermined holes from the chair side of the bracket (G).
3. To ensure the backrest will lock in the folded position, do not insert a plug into the lowest hole position (H).

G. SEAT SLING ADJUSTMENT 16

Remove the screws and rear nut retaining the left side seat sling. Readjust VELCRO®-style material to increase the tension in the seat sling. Replace screws and rear nut. If there is any difficulty in reattaching the screws, try using a probe to help align the holes. Ensure that the plastic saddles are under the seat rail in all fastener positions.

H. ADJUSTING REAR SEAT HEIGHT 17

To adjust rear seat height, loosen and remove the 6 cap screws (I) (3 per side) and nut plate (J) that secure the camber tube clamps (K) to the axle plates (L). Move both camber tube clamps (K) to the desired height and reinstall the 4 cap screws. Prior to tightening, follow the instructions for setting the toe-in/out to zero (Section J-3). Tighten screws to 144 in-lbs. (16.3 Nm).

NOTE– Adjustment to rear seat height may also require caster angle adjustment. See Section M.

I. CUSHION (Optional) INSTALLATION

Place cushion on seat sling with VELCRO® side down. The beveled edge of the cushion should be in front. Press firmly into place.

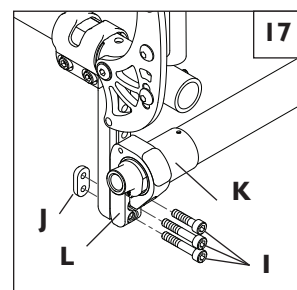
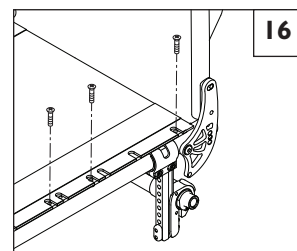
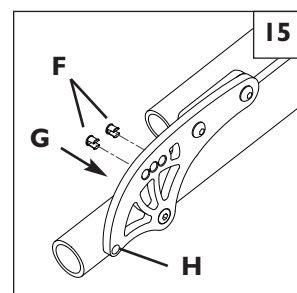
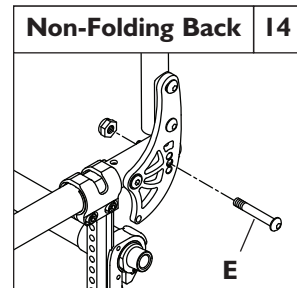
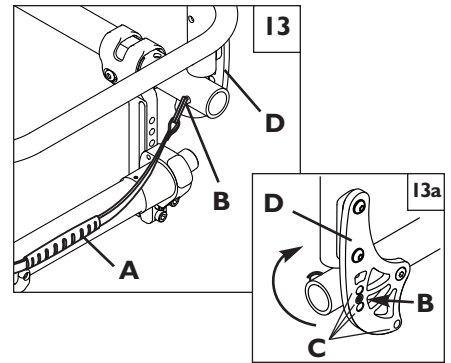

J. REAR AXLE

The most important adjustment on your Quickie wheelchair is the position of the rear axle. The center of gravity and wheel camber are determined by the axle adjustment.

1. Center of Gravity Adjustment 18

WARNING

The more you move your rear wheels forward, the more likely your chair will tip over backwards. Always make adjustments in small increments, and check the stability of your chair with a spotter to prevent a tip-over. We recommend that you use anti-tip tubes until you adapt to the change and are sure you are not at risk to tip over. Refer to additional Warnings in Section VI “Falls and Tip Over”.

NOTE– Changes to the center of gravity may affect the rear seat height (Section H), toe-in/toe-out of the rear wheels (Section J-3) and the squareness of the casters (Section M). If you change your center of gravity position, re-adjust all of these settings if necessary.

NOTE– Adjusting your chair's center of gravity will require re-adjusting the location of the wheel locks (if provided). See Section O for instructions on adjusting the wheel locks.

You can adjust your center of gravity position by moving the two axle plate clamps (A) forward or rearward on the seat tube (B). Moving the axle plate clamps forward shortens the wheelbase and lightens the front end, making your chair more maneuverable. Moving the axle plates rearward makes the chair more stable and less likely to tip over rearward.

To adjust the center of gravity location, remove both rear wheels. Loosen the 4 screws (C) (2 per side) that secure the axle plates (A) to the seat tubes. Slide both axle clamps forward or rearward along the seat tube to the desired position. Make sure both sides are adjusted symmetrically before tightening screws. Tighten screws to 144 in-lbs. (16.3 Nm).

Once the axle plate clamps are secured, attach the rear wheels, occupy the chair and maneuver it with a spotter to get a feel for the new adjustment.

2. Wheel Camber 19

Wheel camber, shown as angular relationship (D), provides greater side-to-side stability due to the increased width and angle of the wheelbase. It also allows for quicker turning and greater access to the top of the handrims.

Wheel camber is determined by pairs of interchangeable camber plugs which are available from your authorized supplier in 0°, 3°, 6° and 9° angles.

3. Setting Toe-in toe-out to zero 20 21 22 23

NOTE– A wheelchair equipped with 0° camber plugs cannot have a toe-in toe-out condition. This adjustment is only required when using 3°, 6° and 9° camber plugs.

Toe refers to how well the rear wheels of the chair are aligned relative to the ground. It affects how well the chair will roll. Drag or rolling resistance is optimally minimized when the wheel toe is set to zero.

Setting the Toe to Zero 20 21

Loosen the 2 cap screws (E) (1 per side) that secure the camber tube clamp. Observe the ball in the level (F), and rotate the camber tube (G) until the ball is centered in the level. The toe is now set to zero.

Before tightening the screws (E), make certain that the camber tube is centered left-to-right relative to the wheelchair frame. There should be an equal gap on both sides or none at all. Torque fasteners (E) to 144 in-lbs. (16.3 Nm).

Setting the Toe to Zero– Alternative Method 20 21 22 23

Place the entire wheelchair on a flat horizontal table or ground surface. Loosen the 2 cap screws (E) (1 per side) that secure the camber tube clamp. Locate the flat surfaces on the front and rear of the camber plugs (H). Place an object that is known to have an accurate 90° corner (such as a carpenter's square, drafting triangle, etc.) down on the flat horizontal surface and up against the flat of the camber plug. Rotate the camber tube and plug assembly until the flat surface of the camber plug is parallel to the measuring tool.

Before tightening the screws (E), make certain that the camber tube is centered left-to-right relative to the wheelchair frame. There should be an equal gap on both sides of the wheelchair or none at all. Torque the fasteners to 144 in-lbs. (16.3 Nm).

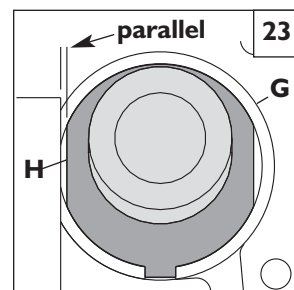
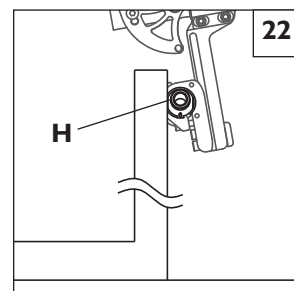
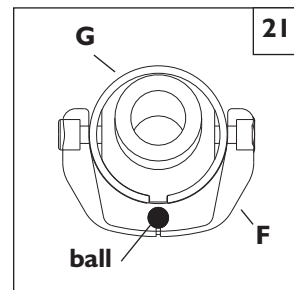
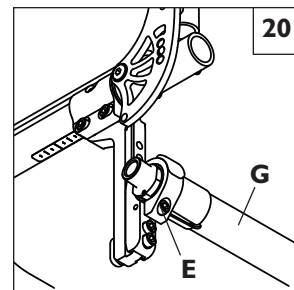
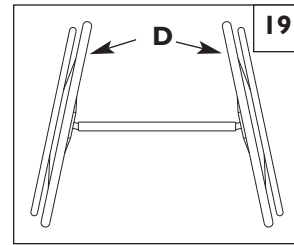
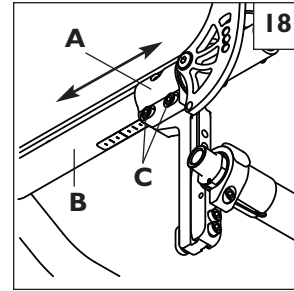

K. GT W/ XTR SUSPENSION REAR AXLE 24 25

The most important adjustment on your Quickie wheelchair is the position of the rear axle. The center of gravity, wheel camber and wheelbase are all determined by the axle adjustment.

NOTE: Use a torque setting of 100 in.-lbs. when adjusting rear axle.

1. Center of Gravity

Moving the center of gravity to the front will lighten the force required to turn the chair. The further back the axle and clamp, the more stable the chair becomes.

The center of gravity is adjusted by moving the rear axle and clamp forward or backward on the frame. Moving the axle and clamp forward will increase your turning speed and lighten the front end.

IMPORTANT NOTE: Changing the center of gravity increases the risk of a fall or tip over. Be very careful to assure the chair will not tip over backwards when tilted.

2. To Move Center of Gravity 24

Loosen bolts (A). Slide camber tube assembly forward or rearward along frame tube (B). Retighten bolts.

3. Wheelbase Width Adjustment 25

Adjusting the wheelbase width allows the rider the option to move the wheels closer or further away from the hips. It also compensates for camber adjustment and gives the proper wheel spacing to maximize pushing efficiency.

Adjust the wheelbase width by loosening the nut (C) and repositioning the axle sleeve (D) into its corresponding hole. Retighten nuts.

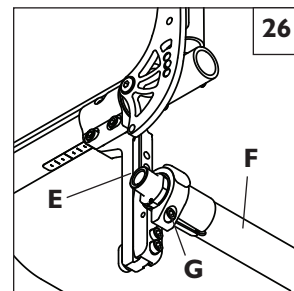
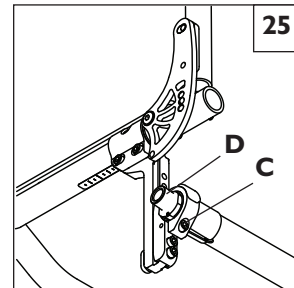
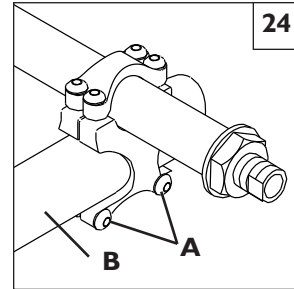

L. REAR WHEEL SPACING 26 27

Rear wheel spacing is measured as the gap between the top of the rear wheels and the back-canes, and is shown as dimension X 27. Factory settings will be as narrow as possible depending on the options chosen.

NOTE- When setting the rear wheel spacing only make adjustments to one side of the chair at a time. Loosening both sides will undo the toe setting.

To adjust the rear wheel spacing, the camber inserts (E) telescope in and out of the camber tube (F) with hard stops at each end of travel. On the left side of the chair, loosen screw (G) (the one closest to the camber tube). Slide the camber insert in or out to establish the required wheel spacing. Tighten screw to 144 in.-lbs. (16.3 Nm). Repeat on the right side of the chair, matching the wheel spacing set on the left side.

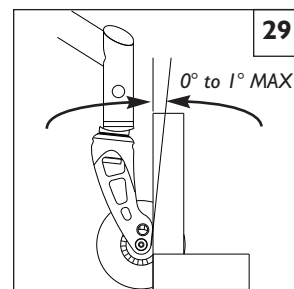
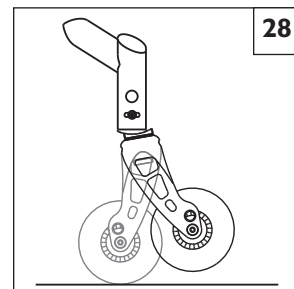
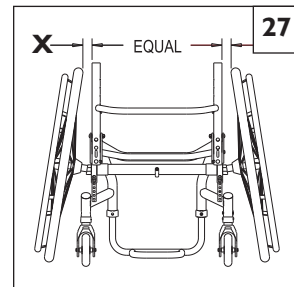

M. CASTERS

NOTE- Setting the wheelchair on a very flat table or a workbench makes this setting more accurate.

1. Adjusting Caster Angle 28 29

Checking for Caster Squareness:

Your Quickie wheelchair leaves the factory with the casters adjusted square. Any time you change your wheelchair rear axle height, rear tire size, center of gravity position or camber tube, you should check that the casters are still square. A caster that is not square will result in the caster lifting off the floor as it rotates around the stem bolt 28 and may also lift the front of the wheelchair up and down. Check for squareness by placing your wheelchair on a flat, horizontal surface. Rotate both forks so that the casters are towards the rear of the wheelchair. Place a square or pocket level against the flat surface on the rear of the fork and note whether this surface is vertical (square) 29. If this surface is more than 1 degree away from vertical, your casters require re-squaring.

2. Re-squaring Your Casters 30 31

Gently pry cap (A) off of both caster tubes. Locate the set screw (B) inside the right caster tube and loosen using an 8mm Allen wrench. Do not remove the set screw. Simply loosen it enough to allow the teeth on the upper and lower splines (C) to clear one another. With the stem bolt loosened, the caster fork should pivot freely. Place the wheelchair on the floor so that the two rear wheels and left caster contact the floor. Place some weight in the seat towards the rear to help stabilize the chair. Place a square or pocket level against the flat surface of the fork and pivot the fork until it is vertical (square) 29. With the fork vertical, engage the teeth of the two splines to the closest mating position. Make certain that the teeth are properly engaged and not crossed. Shine a bright light behind the mating spline teeth and check for proper teeth engagement. Tighten the set screw (B) to secure the spline mating position. The set screw should be tightened to 192 in.-lbs. (21.7 Nm) to ensure that it does not loosen during use.

Record the teeth engagement position of the splines on the right fork, and adjust the left fork in a similar fashion to the same position. Reassemble both casters, and re-check that they are square. Replace caps.

3. 3-D Perpendicular Alignment 31

The allen bolt adjustment (D) provides another dimension of adjustability in addition to the spline system. The bolt may be loosened to relieve tension in the stem assembly. The caster angle may then be fine-tuned and the bolt retightened.

N. FOOTREST HEIGHT ADJUSTMENT 32

To adjust the height of your footrest, loosen the screw (E) on both footrest clamps. Slide the footrest up or down to the new desired height and tighten the two set screws. Use a torque setting of 144 in.-lbs (16.3 Nm). It is recommended that you maintain a minimum of 2.0 inches (5 cm) between the lowest point on the footrest and the floor. This will provide adequate clearance for uneven surfaces and prevent damage to your footrest.

O. WHEEL LOCKS

Quickie GTI Swing-Away and Quickie GTI Fixed Front wheelchairs are shipped with one of five types of wheel locks. Wheel locks are installed at the factory unless you have requested otherwise.

Use a torque setting of 100 in.-lbs. when setting up wheel locks.

1. High-Mount Push-to-Lock or Pull-to-Lock 33,

One-Hand/Unilateral 34

Wheel Locks Adjustment

- Using a 5mm Allen wrench, turn one of the screws (A) in the clamp counterclockwise one-quarter turn.
- Repeat the same process with the second of the two screws.
- Alternately loosen the screws (two turns each) until both screws are removed.
- Slide clamp toward the rear wheel until the wheel lock is embedded into the tire to prevent wheel movement, when in the locked position.
- Tighten screws to 144 in.-lbs. (16.3 Nm).

2. Ergo Scissor Wheel Locks 35 or Compact Wheel Locks

Loosen the screws (G) on the top of each clamp using a 5mm Allen wrench. Slide assembly toward rear wheel until clamp embeds into tire to prevent wheel movement when in locked position. Adjust angle position. Tighten screws to 144 in.-lbs. (16.3 Nm).

NOTE– Clamp and wheel lock may need to be rotated to clear frame tubing.

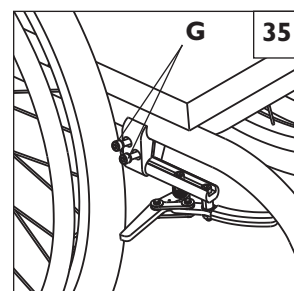
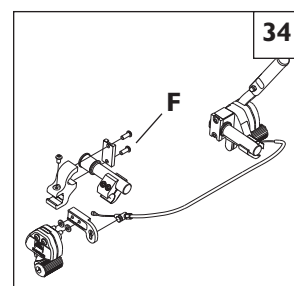
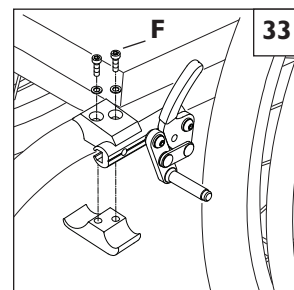
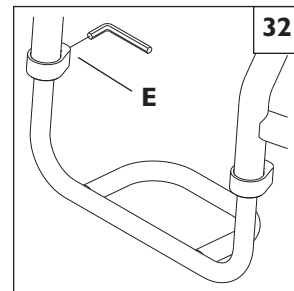
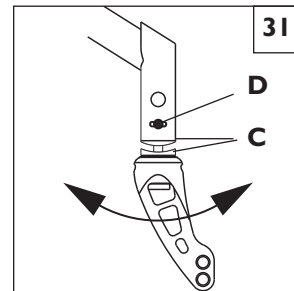
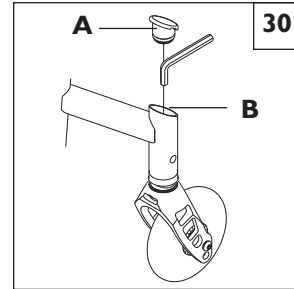

P. ANTI-TIP TUBES (Optional) 36 37

Sunrise Medical recommends anti-tip tubes for all wheelchairs. Use torque setting of 106 in-lbs. (12 Nm) when installing anti-tip tubes.

1. Inserting Anti-tip Tubes Into Receiver 36

- a. Press the rear anti-tip release button (A) on the anti-tip tube so that both release pins are drawn inside.
- b. Insert the anti-tip tube (B) into the anti-tip receiver (C).
- c. Turn the anti-tip tube down until release pin is through the receiver mounting hole.
- d. Insert second anti-tip tube the same way.

2. Adjusting Anti-Tip Tube Wheel 36

The anti-tip wheels may have to be raised or lowered to achieve proper clearance of 1 1/2" to 2".

Press the anti-tip wheel release button (D) so that both release pins are drawn inside. Raise or lower to one of the three predrilled holes (E). Release button. Adjust the second anti-tip tube wheel the same way. Both wheels should be the same height.

3. Turning Anti-Tip Tubes Up 37

Turn anti-tip tubes up when being pushed by attendant, overcoming obstacles or climbing curbs. Press the rear anti-tip tube release button 36-A. Hold lever in and turn anti-tip tube up. Release the lever and repeat with second anti-tip tube. Remember to return anti-tip tubes to down position after completing maneuver.

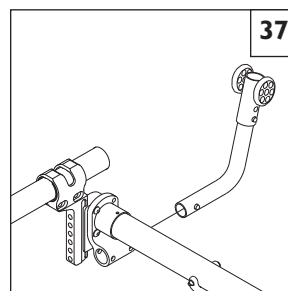
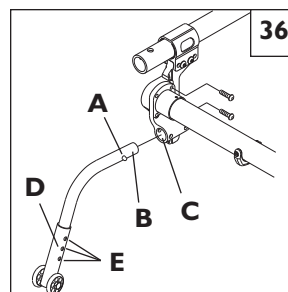

Q. ANTI-TIP SWING AWAY 38

1. Swing-Away Anti-Tip

The anti-tip wheel may have to be raised or lowered to achieve proper clearance of 1 1/2" to 2".

To adjust, using an Allen key and wrench, remove bolt (F) from current position. Adjust to proper height, reinsert bolt, and tighten back into place.

2. Positioning Swing-Away Anti-Tip

The Swing-Away Anti-Tip can be positioned in the forward position when the wheelchair is being pushed by the attendant, overcoming obstacles or climbing curbs. Press release tab (G) in a downward motion and swing the anti-tip to either the forward or rearward position. The anti-tip will lock back into place by moving upward. Remember to return the anti-tip to the rearward position after completing the maneuver.

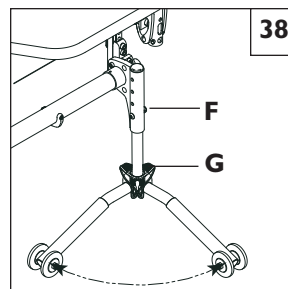

R. GT W/XTR SUSPENSION ANTI-TIP TUBES (Optional) 39 40

Sunrise Medical recommends anti-tip tubes for all wheelchairs.

NOTE- Use torque setting of 100 in./lbs. when setting-up anti-tip tubes.

1. Inserting Anti-tip Tubes Into Receiver

- a. Press the rear anti-tip release lever on the anti-tip tube so that both release pins are drawn inside.
- b. Insert the tube into the anti-tip receiver.
- c. Turn the anti-tip tube down until release pin is through the receiver mounting hole.
- d. Insert second anti-tip tube the same way.

2. Adjusting Anti-tip Receiver

- a. Remove anti-tip tubes from anti-tip receivers.
- b. Remove button head bolt from anti-tip tube receiver.
- c. Reposition bracket to desired height.
- d. Reinsert button-head bolt and tighten.
- e. Repeat with second anti-tip tube receiver. Both brackets should be at exactly the same height.

3. Adjusting Anti-Tip Tube Wheel

The anti-tip wheels may have to be raised or lowered to achieve proper clearance of 1 1/2" to 2".

Press the anti-tip wheel release button so that both release pins are drawn inside. Raise or lower to one of the three predrilled holes. Release button. Adjust the second anti-tip tube wheel the same way. Both wheels should be exactly the same height.

4. Turning Anti-Tip Tubes Up

Turn anti-tip tubes when being pushed by attendant, overcoming obstacles or climbing curbs. Press the rear anti-tip tube release lever. Hold lever in and turn anti-tip tube up. Release the lever and repeat with second anti-tip tube. Remember to return anti-tip tubes to down position after completing maneuver.

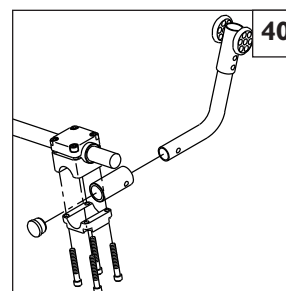
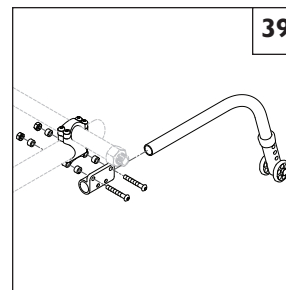

S. REAR SUSPENSION 41

The performance of your suspension system is determined by the compression elastomers (A). There are several different elastomers available from Quickie which are selected based on the user's weight.

To change out elastomers, remove the 2 screws (B) (1 per side). Rotate swingarms (C) downward and the compression elastomer (A) can be freely removed from its top and bottom engagement sockets.

Reverse the order to install new bushings, making sure the compression elastomers are securely engaged into the top and bottom sockets.

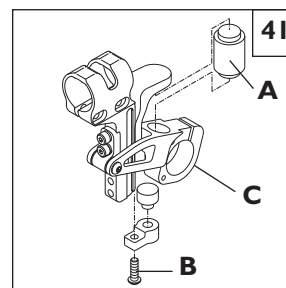

T. XTR SUSPENSION 42

- Tuned to perform in conjunction with Quickie GT.
 - Adjustable spring pre-load
1. If the shock ever loses oil or if it makes sounds of excessive topping out, stop use immediately and have the shock inspected by a dealer. Continued use with the shock in either of these conditions could result in loss of control with possible serious and/or fatal injuries.
 2. Always use genuine Quickie parts. Use of after-market replacement parts voids the warranty and could cause structural failure to the shock. Structural failure could result in loss of control with possible serious and /or fatal injuries

Tuning Your Shock

By matching the proper spring rate and damping adjustment, your shocks can be tuned to your weight.

When tuning suspension, always make one change at a time and write it down. This takes patience, but allows you to understand how each change affects your ride. Keeping a record lets you know what changes you have tried that work and suggests what changes you might try.

Maintenance

Shocks are designed for high performance. To insure this, we recommend keeping the shaft area, seal cover and bottom out bumper as clean as possible. It is also recommended that the shock be overhauled by a qualified mechanic with proper tools once a year.

Over time, the oil inside the shock will degrade and the shock will start to loose damping. The shock will compress and rebound too fast when damping loss is significant. This indicates the shock needs to be serviced. This service should only be performed by a dealer.

Washing Your Deluxe Shock

Clean your shock with mild soap and a toothbrush. Keep the shaft and body eye bushings cleaned and greased.

IMPORTANT: NEVER USE A HIGH-POWERED WASHER FOR CLEANING THE SHOCK!

Oil Change Intervals

We recommend that the oil be changed in your shock annually. However, if you ride in extreme conditions the oil should be changed more often than once a year.

Oil Leaks

One hundred percent serviceable. Contact your dealer to have your shock serviced.

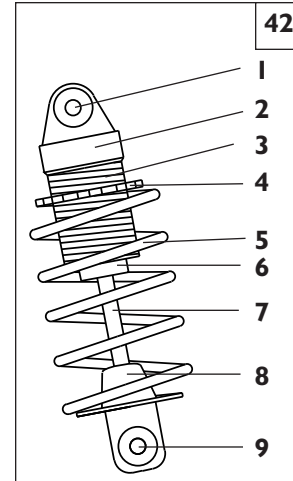

1. Body eye
2. Reservoir
3. Body threads
4. Spring preloaded adjuster ring
5. Coil spring
6. Seal head
7. Shock shaft
8. Bottom out bumper
9. Shaft eye

U. TRAVEL WHEELS 43 44

1. Removing Travel Wheels from Receivers 43

- a. Remove the quick-release pin (A).
- b. Remove the travel wheel (B) from the receiver (C).
- c. Repeat for other side.

2. Inserting Travel Wheels into Receivers 43

- a. Insert the travel wheel (B) into the receiver (C).
- b. Align holes at position for corresponding rear wheel size.
- c. Insert the quick-release pin (A) fully.
- d. Repeat for other side. Both travel wheels must be set at the same height.

3. Adjusting Travel Wheels for Frame Angle 43 44

The travel wheel bracket (D) alignment may need to be adjusted depending upon the angle of the frame's seat rail. The travel wheel brackets have two hole patterns that offer 2 "Trail" positions 43. To adjust the mounting configuration:

- a. Remove the 2 mounting screws (E).
- b. Rotate the travel wheel bracket (D) to the hole pattern that creates the smallest "Trail" dimension. Always keep the travel wheel behind the axle centerline.
- c. Replace the 2 mounting screws (E), and torque to 106 in-lbs. (12 Nm).
- d. Repeat for other side. Both travel wheels must be set at the same angle.

NOTE— When the wheelchair is configured with the travel wheel and anti-tip options, the travel wheel bracket (D) is installed between the camber tube clamp (F) and anti tip receiver bracket (not shown).

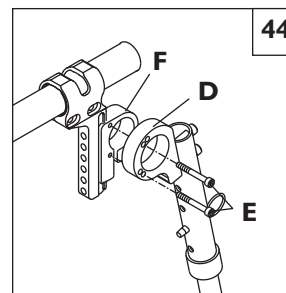
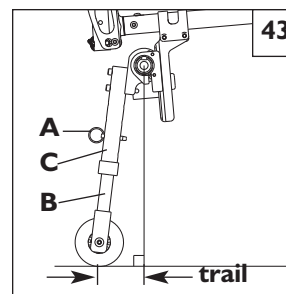

V. CHECK-OUT

After the wheelchair is assembled and adjusted, it should roll smoothly and easily. All accessories should also perform smoothly. If you have any problems, follow these procedures:

- a. Review assembly and adjustment sections to make sure chair was properly prepared.
- b. Review trouble shooting guide.
- c. If your problem persists, contact your authorized supplier. If you still have a problem after contacting your authorized supplier, contact Sunrise customer service. See the introduction page for details on how to contact your authorized supplier or Sunrise customer service.

X. TROUBLESHOOTING

You will need to adjust your chair from time to time for best performance (especially if you alter the original settings). This chart gives you a first solution, then a second and a third if needed. You may need to look farther to find the best solution for a specific problem.

NOTE- To keep track of your progress, make only **ONE** change at a time.

SYMPTOMS						SOLUTIONS
Left turn in chair	Right turn in chair	Looseness in chair	Sluggish turning	Squeaks and rattles	Caster flutter	
✓	✓	✓	✓			Make sure tire pressure is correct and equal in both rear tires and front caster tires, if pneumatic.
		✓	✓	✓	✓	✓ Make sure all nuts and bolts are snug.
		✓		✓		Make sure all spokes and nipples are tight on radial spoke wheels.
				✓		Use Tri-Flow Lubricant (Teflon®-based) between all modular frame connections and parts.
✓	✓		✓		✓	Check for proper caster housing adjustment. See instructions for caster adjustment.
			✓			Check for proper toe-in/out adjustment. See instructions for proper adjustment.

XI. MAINTENANCE

A. INTRODUCTION

1. Proper maintenance will improve performance and extend the useful life of your chair.
2. Clean your chair regularly. This will help you find loose or worn parts and make your chair easier to use.
3. Repair or replace loose, worn, bent or damaged parts **before using this chair**.
4. To protect your investment, have all major maintenance and repair work done by your authorized supplier.

WARNING

If you fail to heed these warnings your chair may fail and cause severe injury to the rider or others.

1. Inspect and maintain this chair strictly per chart.
2. If you detect a problem, make sure to service or repair the chair before use.
3. At least once a year, have a complete inspection, safety check and service of your chair made by an authorized supplier.

B. MAINTENANCE CHART

	Weekly	3 Months	6 Months	Annually	CHECK...
✓					Tire inflation level
✓					Wheel locks
	✓				All fasteners for wear and tightness
		✓			Armrests
	✓				Footrests
		✓			Camber tube and camber plugs
	✓				Quick-release axles
	✓				Wheels, tires and spokes
	✓				Rear Suspension
	✓				Caster angle adjustment
	✓				Casters
	✓				Anti-tip tubes
		✓			Frame
	✓				Upholstery
			✓		Service by Authorized Supplier

C. MAINTENANCE TIPS

1. Axles & Axle Sleeves

Check axles and axle sleeves every six months to make sure they are tight. Loose sleeves will damage the camber tube and will affect performance.

2. Tire Air Pressure

Check air pressure in pneumatic tires at least ONCE A WEEK. The wheel locks will not grip properly if you fail to maintain the air pressure shown on tire sidewall.

3. Wheel Locks

Inspect the wheel locks and their frame attachment brackets weekly, ensuring that all fasteners are tight and the wheel lock arms embed in tires at least 1/8 inch when locked.

4. Armrests

Inspect the armrest attachment brackets and the armrest at least every 6 months ensuring that all fasteners are tight and no parts have moved from their preset position.

5. Camber Tubes and Camber Plugs

Inspect the camber tubes and plugs every 6 months ensuring that all fasteners are tight and no parts have moved from their preset position.

6. Wheelchair Frame

Inspect the wheelchair frame for cracks, dings and dents every 6 months, more frequently if used more aggressively.

7. Upholstery

Inspect the upholstery fabric for wear and tear every 3 months. Sling fabric will weaken with age and use. Look for fraying or thin spots, or stretching of fabrics at rivet holes.

D. CLEANING

1. Paint Finish

- a. Clean the painted surfaces with mild soap at least once a month.
- b. Protect the paint with a coat of non-abrasive auto wax every three months.

2. Axles and Moving Parts

- a. Clean around axles and moving parts WEEKLY with a slightly damp (not wet) cloth.
- b. Wipe off or blow away any fluff, dust, or dirt on axles or moving parts.

NOTE— You do not need to grease or oil the chair.

3. Upholstery

- a. Hand-wash (machine washing may damage fabric).
- b. Drip-dry only. DO NOT machine dry as heat will damage fabric.

E. STORAGE TIPS

1. Store your chair in a clean, dry area. If you fail to do so, parts may rust or corrode.
2. Before using your chair, make sure it is in proper working order. Inspect and service all items on the "Maintenance Chart".
3. If stored for more than three months, have your chair inspected by an authorized supplier before use.

XII. SUNRISE LIMITED WARRANTY**A. FOR LIFETIME**

Sunrise warrants the frame and cross brace if applicable of this wheelchair against defects in materials and workmanship for the life of the original purchaser.

The expected life of this frame is five years.

B. FOR ONE (1) YEAR

We warrant all Sunrise-made parts and components of this wheelchair against defects in materials and workmanship for one year from the date of first consumer purchase.

C. LIMITATIONS

1. We do not warrant:
 - a. Tires and tubes, upholstery, pads and push-handle grips.
 - b. Damage from neglect, accident, misuse, or from improper installation or repair.
 - c. Products modified without Sunrise Medicals express written consent.
 - d. Damage from exceeding the weight limit.
2. This warranty is VOID if the original chair serial number tag is removed or altered.
3. This warranty applies in the USA only. Check with your supplier to find out if international warranties apply.
4. This warranty is not transferable and only applies to the first consumer purchase of this wheelchair through an authorized Sunrise Medical dealer.

D. WHAT WE WILL DO

Our sole liability is to repair or replace covered parts. This is the exclusive remedy for consequential damages.

E. WHAT YOU MUST DO

1. Obtain from us, while this warranty is in effect, prior approval for return or repair of covered parts.
2. Return the wheelchair or part(s), freight pre-paid, to Sunrise Mobility Products Division at: 2842 Business Park Avenue, Fresno, CA 93727-1328.
3. Pay the cost of labor to repair, remove or install parts.

F. NOTICE TO CONSUMER

1. If allowed by law, this warranty is in place of any other warranty (written or oral, express or implied, including a warranty of merchantability, or fitness for a particular purpose).
2. This warranty gives you certain legal rights. You may also have other rights that vary from state to state.

Record your serial number here for future reference:

Sunrise Medical Inc.
7477 East Dry Creek Parkway
Longmont, Colorado 80503
USA
(800) 333-4000
In Canada (800) 263-3390
www.sunrisemedical.com



www.sunrisemedical.com

©2009 Sunrise Medical Inc. 2.09
109880 Rev. A